

# Owner's Guide

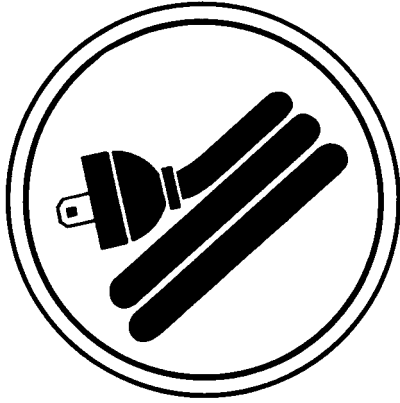

## 20-inch Manual Clean Electric Range

### TABLE OF CONTENTS

<b>IMPORTANT SAFETY INSTRUCTIONS</b> .....	2-4	• Baking problem chart .....	9
<b>ABOUT YOUR COOKTOP</b> .....	5-6	<b>ABOUT YOUR RANGE</b> .....	10-11
• How to set surface unit .....	5-6	• Oven door .....	10
• Cooktop .....	6	• Oven vent .....	10
• Coil Elements .....	6	• Leveling legs .....	10
<b>ABOUT YOUR OVEN</b> .....	7-9	• Oven rack .....	11
• Aluminum foil usage .....	7	<b>CLEANING CHART</b> .....	12-13
• Preheating .....	7	<b>ABOUT SERVICE</b> .....	14-15
• How to set oven .....	7	• Troubleshooting Chart .....	14-15
• Cooking tips .....	8	<b>WARRANTY</b> .....	16

**INSTALLER** Please leave this manual with this appliance.

**CONSUMER** Please read and keep this manual for future reference. Keep sales receipt and/or cancelled check as proof of purchase.

Model Number: \_\_\_\_\_

Serial Number: \_\_\_\_\_

Date of Purchase: \_\_\_\_\_

Model and serial numbers are on the rating plate, which is located across the bottom side of the manifold. Open the oven door to see the rating plate.

**FOR CUSTOMER ASSISTANCE CALL**

**1-800-688-9900 USA**

**1-800-688-2002 Canada**

**8113P743-60**

A/01/08

## 2

# IMPORTANT SAFETY INSTRUCTIONS

**Thank You** . . . for purchasing our cooking appliance. To help you obtain the maximum in cooking satisfaction, we offer these suggestions:

- ☞ Read this manual before using the appliance.
- ☞ Review all safety and caution instructions.
- ☞ Review the Troubleshooting Chart on pages 14 and 15 if service becomes necessary.
- ☞ Include the model and serial numbers of your appliance when requesting service.
  - Proof of purchase such as sales receipt will be needed for warranty service.

☞ You can contact us at:

Maytag Appliances Sales Company  
Attn: CAIR<sup>SM</sup> Center  
P. O. Box 2370  
Cleveland, TN 37320-2370  
**1-800-688-9900 USA 1-800-688-2002 Canada**

In our continuing effort to improve the quality and performance of our cooking appliances, it may be necessary to make changes to the appliance without revising this manual.

**Read and follow all instructions before using this appliance** to prevent the potential risk of fire, electric shock, personal injury or damage to the appliance as a result of improper usage of the appliance. Use appliance only for its intended purpose as described in this manual.

**To ensure proper and safe operation:** Appliance must be properly installed and grounded by a qualified technician.

	<b>⚠ WARNING</b>
	<ul style="list-style-type: none"><li>• <b>ALL RANGES CAN TIP AND CAUSE INJURIES TO PERSONS.</b></li><li>• <b>INSTALL ANTI-TIP DEVICES PACKED WITH RANGE.</b></li><li>• <b>FOLLOW ALL INSTALLATION INSTRUCTIONS.</b></li></ul>

**WARNING:** To reduce risk of tipping of the appliance from abnormal usage or by excessive loading of the oven door, the appliance must be secured by a properly installed anti-tip device.

Check if device is properly installed. Remove the four screws that secure the lower panel to the range.

Look underneath range to make sure one of the rear leveling legs is properly engaged in the bracket slot. The anti-tip device secures the rear leveling leg to the floor when properly engaged. You should check this **anytime** the range has been moved.

## IN CASE OF FIRE

Turn off appliance and ventilating hood to avoid spreading the flame. Extinguish flame then turn on hood to remove smoke and odor.

- **Cooktop:** Smother fire or flame in a pan with a lid or cookie sheet.

**NEVER** pick up or move a flaming pan.



- **Oven:** Smother fire or flame by closing the oven door.

Do not use water on grease fires. Use baking soda, a dry chemical or foam-type extinguisher to smother fire or flame.

# IMPORTANT SAFETY INSTRUCTIONS

3

## GENERAL INSTRUCTIONS

**WARNING: NEVER** use appliance door, or drawer, if equipped, as a step stool or seat as this may result in possible tipping of the appliance, damage to the appliance, and serious injuries.



If appliance is installed near a window, proper precautions should be taken to prevent curtains from blowing over surface elements.

**NEVER** use appliance to warm or heat the room. Failure to follow this instruction can lead to possible burns, injury, fire, or damage to the appliance.



**NEVER** wear loose-fitting or hanging garments while using the appliance. Clothing could catch utensil handles or ignite and cause burns if garment comes in contact with hot heating elements.



To ensure proper operation and to avoid damage to the appliance or possible injury, do not adjust, service, repair or replace any part of the appliance unless specifically recommended in this manual. Refer all other servicing to a qualified technician.

**NEVER** store or use gasoline or other combustible or flammable materials in the oven, near surface units or in the vicinity of this appliance as fumes could create a fire hazard or an explosion.

To prevent grease fires, do not let cooking grease or other flammable materials accumulate in or near the appliance.

Use only dry potholders. Moist or damp potholders on hot surfaces may result in a steam burn. Do not let potholder touch hot heating elements. Do not use a towel or other bulky cloth which could easily touch hot heating elements and ignite.

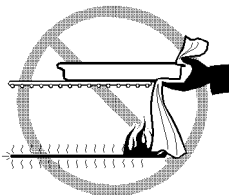

Always turn off all controls when cooking is completed.

**NEVER** heat unopened containers on the surface unit or in the oven. Pressure build-up in the container may cause container to burst resulting in burns, injury or damage to the appliance.

**NEVER** use aluminum foil to line drip bowls, or to cover an oven rack or oven bottom. Misuse could result in risk of electric shock, fire, or damage to the appliance. Use foil only as directed in this manual.

## COOKTOP

**NEVER** leave surface units unattended especially when using high heat settings. An unattended boilover could cause smoking and a greasy spillover can cause a fire.



This appliance is equipped with different size surface elements. Select pans having flat bottoms large enough to cover element. Proper relationship of pan to element will improve cooking efficiency.

If pan is smaller than element, a portion of the element will be exposed to direct contact and could ignite clothing or potholder.

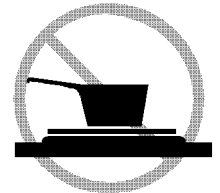

Only certain types of glass, glass/ceramic, ceramic, earthenware, or other glazed utensils are suitable for cooktop or oven service without breaking due to the sudden change in temperature. Follow utensil manufacturer's instructions when using glass.

Turn pan handle toward center of cooktop, not out into the room or over another surface element. This reduces the risk of burns, ignition of flammable materials, or spillage if pan is accidentally bumped or reached by small children.



To prevent damage to removable heating elements, do not immerse, soak or clean in a dishwasher or self-clean oven. A damaged element could short resulting in a fire or shock hazard.

Make sure drip bowls are in place as absence of these bowls during cooking could damage wiring or parts.

# 4

## IMPORTANT SAFETY INSTRUCTIONS

### OVEN

Use care when opening door. Let hot air or steam escape before removing or replacing food.

For proper oven operation and performance, do not block or obstruct oven vent duct.

Always place oven racks in desired locations while oven is cool. If rack must be moved while oven is hot, do not let potholder contact hot heating element in oven.

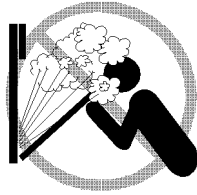

### VENTILATING HOODS

Clean range hood and filters frequently to prevent grease or other flammable materials from accumulating on hood or filter and to avoid grease fires.

Turn the fan on when flambéing foods (such as Cherry Jubilee) under the hood.

### DEEP FAT FRYERS

Use extreme caution when moving the grease kettle or disposing of hot grease. Allow grease to cool before attempting to move pan.

### HEATING ELEMENTS

**NEVER** touch surface or oven heating elements, areas near elements or interior surfaces of oven.

Heating elements may be hot even though they are dark in color. Areas near surface elements and interior surfaces of an oven may become hot enough to cause burns. During and after use, do not touch or let clothing or other flammable materials contact heating elements, areas near elements, or interior surfaces of oven until they have had sufficient time to cool.

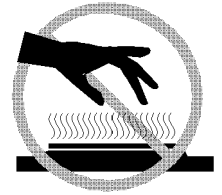

Other potentially hot surfaces include: Cooktop, areas facing the cooktop, oven vent opening, surfaces near the vent opening, oven door, areas around the door, and oven window.

### CHILD SAFETY

**NEVER** leave children alone or unsupervised in area where appliance is in use or is still hot.

**NEVER** allow children to sit or stand on any part of the appliance as they could be injured or burned.

**CAUTION: NEVER** store items of interest to children in cabinets above an appliance or on backguard of a range. Children climbing on appliance, door or drawer to reach items could damage the appliance or be burned or seriously injured.

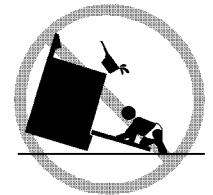

Children must be taught that the appliance and utensils in or on it can be hot. Let hot utensils cool in a safe place, out of reach of small children. Children should be taught that an appliance is not a toy. Children should not be allowed to play with controls or other parts of the unit.

# ABOUT YOUR COOKTOP

5



## Before cooking . . .

- Always place a pan on the surface unit **before** you turn it on. To prevent damage to range, **never** operate surface unit without a pan in place.
- **NEVER** use the cooktop as a storage area for food or cookware.

## During cooking . . .

- Be sure you know which knob controls which surface unit. Make sure you turned on the correct surface unit.
- Begin cooking on a higher heat setting then **reduce** to a lower setting to complete the operation. Never use a high heat setting for extended cooking.
- **NEVER** allow a pan to boil dry. This could damage the pan and the appliance.
- **NEVER** touch cooktop until it has cooled. Expect some parts of the cooktop, especially around the surface units, to become warm or hot during cooking. Use potholders to protect hands.

## After cooking . . .

- Be sure surface element is off after cooking.
- Clean up greasy spills as soon as possible.

## Other tips . . .

- To eliminate the hazard of reaching over hot surface elements do not install cabinet storage directly above a unit.

If storage is provided, limit it to items that are infrequently used and can be safely stored in an area subjected to heat.

Temperatures may be unsafe for items such as volatile liquids, cleaners or aerosol sprays.

- Aerosol-type spray cans are **EXPLOSIVE** or highly flammable when exposed to heat. Avoid their use or storage near an appliance.
- **NEVER** leave any items, especially plastic items, unattended on the cooktop. The hot air from the vent may ignite flammable items, melt or soften plastics, or increase pressure in closed containers causing them to burst.
- **NEVER** allow aluminum foil, meat probes or any other metal object, other than a utensil on a surface element, to contact heating elements.

## SURFACE INDICATOR LIGHT

A SURFACE indicator light, located on the manifold panel, will turn on whenever a surface unit is turned on. Light will turn off when surface unit is turned off.

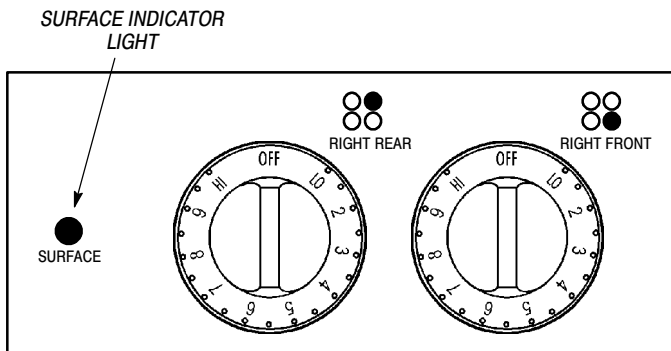

## HOW TO SET SURFACE UNIT

1. Place pan on surface unit.
2. Push in and turn knob to desired setting.
  - Each knob is identified by international symbols located below each knob.
  - Knob can be turned in either direction.
  - Knob can be set on any number or between any numbers.

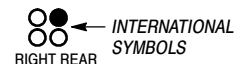
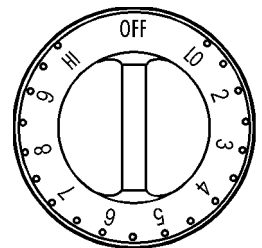

3. After cooking, turn knob to OFF then remove pan.

## SELECTING HEAT SETTINGS

- If a higher setting is used to begin a cooking operation or to bring water to a boil, always **reduce** to a lower setting once cooking begins or water comes to a boil.
- For smoothtop cooking, it is better to select a lower setting and increase to a higher one later, if needed.
- Food will not cook faster at a setting that is higher than needed to maintain a gentle boil. The temperature of the water is the same whether boiling vigorously or gently.

### Factors affecting the heat setting include:

- Type, flatness and size of the cookware.
- Quantity and type of food being cooked.
- Use of a lid (covering pans speeds cooking and saves energy).
- Element voltage or voltage supply to your home.

## SUGGESTED HEAT SETTING GUIDE

When turning knob to HIGH, there is an indent to identify the HIGH setting.

**HIGH OR 9:** Use to bring liquid to a boil, blanch, preheat skillet, or reach pressure in a pressure cooker. **Always** reduce to a lower heat setting when liquid just begins to boil or food begins to cook.

**MEDIUM-HIGH (7, 8):** Use to brown or sear meat; heat oil for deep fat frying; scald; to saute or fry. Maintain fast boil for large amounts of liquid.

**MEDIUM (4, 5, 6):** Use to maintain moderate to slow boil for large amounts of liquid. To continue cooking uncovered food and for most frying operations.

**MEDIUM-LOW (2,3):** Use to continue cooking covered food and to maintain pressure in most pressure cookers. Stew, braise or steam operations. To maintain boil for small amounts of liquid, poach, steam or simmer.

**LOW OR 1:** Use to keep food warm before serving. Melt chocolate or butter.

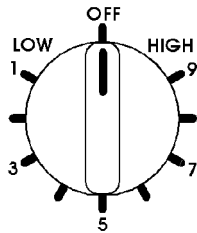

## COIL ELEMENTS

- When an element is turned on, it will cycle on and off to maintain the heat setting.
- Coil surface elements are self-cleaning.
- Do not immerse elements in water.

### To remove element:

1. When cool, raise element.
2. Carefully pull out and away from receptacle.

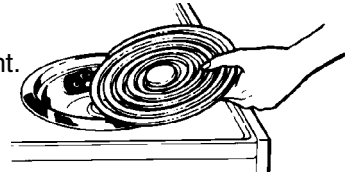

### To replace element:

1. Insert terminals on the element into receptacle.
2. Gently lift up on outer edge of element while inserting terminals into receptacle.
3. Gently press down on outer edge of element until element sits level on drip bowl.



**NOTE:** When replacing element, be sure support leg on element is inserted into the slot in the front of the drip bowl.

## DRIP BOWLS

- Be sure drip bowl is properly installed and in place.
- Drip bowl will not “rock” when installed properly. Notch above opening on bowl should be centered over screw that secures receptacle to the cooktop.
- Absence of these bowls during cooking may subject wiring or component parts underneath the cooktop to damage.
- To prevent risk of electric shock or fire, never line drip bowls with aluminum foil.
- **Chrome** drip bowls will turn blue or gold over time or if overheated. This type of discoloration is normal and permanent. It will not affect cooking performance.
- To protect the **chrome** finish:
  - Avoid using high settings for long periods of time.
  - Reduce to a lower setting once food begins cooking.
  - Do not use oversized cookware. Pan should not extend more than 1 inch from the element.
  - Clean bowls after each use.

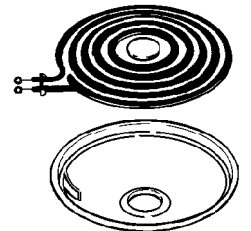

# ABOUT YOUR OVEN

7

## OVEN INDICATOR LIGHT

The OVEN indicator light, located on the manifold panel, turns on whenever the oven turns on.

When the oven reaches the preset temperature, the indicator light turns off.

The OVEN indicator light will then turn off and on as the oven elements cycle off and on to maintain the preset oven temperature.

OVEN INDICATOR LIGHT

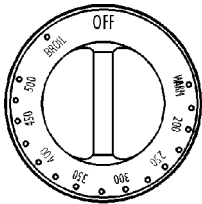

OVEN

## ALUMINUM FOIL USAGE

- Do not cover an entire oven rack or oven bottom with aluminum foil. This will reduce heat circulation, result in poor baking and may damage the oven bottom.
- Do not cover the broiler insert with aluminum foil. This prevents fat from draining into the pan below and increases flare-ups and smoke. However, the broiler pan may be lined with foil for easier clean-up.

## PREHEATING

- Preheating is necessary for baking.
- It is not necessary to preheat for roasting.
- To preheat, set the oven to the desired temperature and allow about 8 to 15 minutes for the oven to preheat.
- When the oven reaches the preset temperature, the oven indicator light will turn off.
- Selecting a temperature higher than desired will NOT preheat the oven any faster, and may have a negative effect on baking results.

## OVEN CONTROL

The OVEN TEMP knob is used to select the oven temperature.

Always turn this knob just TO the desired temperature.

To accurately set the oven temperature, do not turn to a higher temperature and then back.

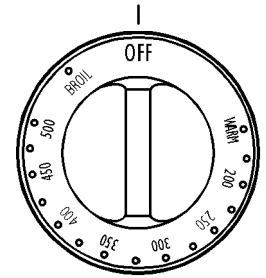

OVEN TEMP

## HOW TO SET OVEN TO BAKE

1. When cool, position rack in oven.
2. Turn OVEN TEMP knob to desired temperature.
3. Place food in center of oven, allowing a minimum of 2 inches between utensil and oven walls.
4. Check food for doneness at minimum time in recipe. Cook longer if necessary.
5. Remove food from the oven and turn the OVEN TEMP knob to OFF.

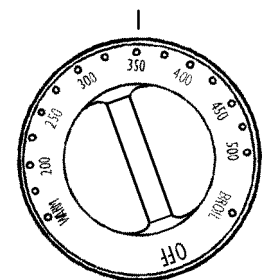

OVEN TEMP

## HOW TO SET OVEN TO BROIL

- 1 Place oven rack on the recommended rack position.
- 2 Turn OVEN TEMP knob to BROIL.
3. If desired, preheat broil element 3 minutes before placing meat in the oven.
4. Turn meat once about halfway through cooking.
5. Remove food from oven and turn the OVEN TEMP knob to OFF.

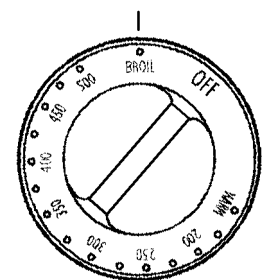

OVEN TEMP

## BROILING CHART

TYPE OF MEAT	RACK POSITION	TOTAL TIME (MINUTES)
BACON	#3	6 to 10
BEEF STEAK 1-inch thick	#3 #3	15 to 18 (med) 19 to 23 (well)
CHICKEN Pieces	#2 or 1	30 to 45
FISH	#3	8 to 15
HAMBURGERS 3/4-inch thick	#3	15 to 18

## BAKING TIPS

Use a **reliable recipe** and accurately measure fresh ingredients. **Carefully follow directions** for oven temperature and cooking time. Preheat oven if recommended.

**Use the correct rack position.**

Baking results may be affected if the wrong rack position is used.

- Top browning may be darker if food is located toward the top of the oven.
- Bottom browning may be darker if food is located toward the bottom of the oven.

**Bakeware material** plays an important part in baking results. Always use the type and size of pan called for in the recipe. Cooking times or cooking results may be affected if the wrong size is used.

- **Shiny metal pan** reflects heat away from the food, produces lighter browning and a softer crust. Use shiny pans for baking cakes or cookies.
- **Dark metal pan or a pan with an anodized (dull) bottom** absorbs heat, produces darker browning and a crisper crust. Use this type of pan for pies, pie crusts or bread.
- If using **oven-proof glassware**, or **dark pans such as Baker's Secret** reduce the oven temperature by 25°F except when baking pies or bread. Use the same baking time as called for in the recipe.
- If using insulated bakeware, expect cooking times to increase slightly. It is not necessary to adjust the oven temperature.

**If you add additional ingredients** or alter the recipe, expect cooking times to increase or decrease slightly.

## ROASTING TIPS

Roasting is the method for cooking large, tender cuts of meat uncovered, without adding moisture. Most meats are roasted at 325°F. It is not necessary to preheat the oven.

Place the meat fat-side-up on a rack in a shallow roasting pan. Placing the meat on a rack holds it out of the drippings, thus allowing better heat circulation for even cooking. As the fat on top of the roast melts, the meat is basted naturally, eliminating the need for additional basting.

The cooking time is determined by the weight of the meat and the desired doneness.

For more accurate results, use a meat thermometer. Insert it so the tip is in the center of the thickest part of the meat. It should not touch fat or bone.

Remove the roast from the oven when the thermometer registers the desired doneness.

**NOTE:** For more information about food safety, call USDA's Meat & Poultry Hotline at 1-800-535-4555.

For cooking information, write to the National Cattlemen's Beef Association, 444 North Michigan Avenue, Chicago, Illinois 60611, or call 1-800-368-3138.

## BROILING TIPS

Broiling is used for tender cuts of meat or marinated meats, poultry, fish and some fruits and vegetables. The food is placed directly under the broil element.

Cooking time is determined by the desired degree of doneness and the distance between the food and the element.

For best results, steaks and chops should be at least 3/4-inch thick. Trim excess fat to prevent excessive spattering or smoking. Cut slashes in the outer edges of the fat to prevent curling during cooking.

Use a broiler pan with an insert designed to drain excess liquid and fat away from the cooking surface. This is to prevent spatters and smoke.

When broiling open the door to the broil stop position (opened about 4-inches).

For a brown exterior and rare interior, meat should be close to the broil element. For well-done meat, place the broiler pan farther from the element.

Increasing the distance between the meat and the broil element will help reduce spattering and smoking.

Foods that require turning should be turned only once during broiling. Turn after half the recommended cooking time.

## COMMON BAKING PROBLEMS AND WHY THEY HAPPEN

PROBLEM	POSSIBLE CAUSES
<b><i>Cakes are uneven.</i></b>	<ul style="list-style-type: none"> <li>• Pans too close or touching each other or oven walls.</li> <li>• Batter uneven in pans.</li> <li>• Temperature set too low or baking time too short.</li> <li>• Oven not level.</li> <li>• Undermixing.</li> <li>• Too much liquid.</li> </ul>
<b><i>Cake high in middle.</i></b>	<ul style="list-style-type: none"> <li>• Temperature set too high.</li> <li>• Baking time too long.</li> <li>• Overmixing.</li> <li>• Too much flour.</li> <li>• Pans touching each other or oven walls.</li> <li>• Incorrect rack position.</li> </ul>
<b><i>Cake falls.</i></b>	<ul style="list-style-type: none"> <li>• Too much shortening or sugar.</li> <li>• Too much or too little liquid.</li> <li>• Temperature set too low.</li> <li>• Old or too little baking powder.</li> <li>• Pan too small.</li> <li>• Oven door opened frequently.</li> <li>• Added incorrect type of oil to cake mix.</li> <li>• Added additional ingredients to cake mix or recipe.</li> </ul>
<b><i>Cakes, cookies, biscuits don't brown evenly.</i></b>	<ul style="list-style-type: none"> <li>• Incorrect rack position.</li> <li>• Oven door not closed properly.</li> <li>• Door gasket not sealing properly or properly attached to door.</li> <li>• Incorrect use of aluminum foil.</li> <li>• Oven not preheated.</li> <li>• Pans darkened, dented or warped.</li> </ul> <p>For optimum results, bake on one rack. If baking cakes on two racks, place pans toward the front of the oven on the upper rack and toward the back of the oven on the lower rack.</p>
<b><i>Cakes, cookies, biscuits too brown on bottom.</i></b>	<ul style="list-style-type: none"> <li>• Oven not preheated.</li> <li>• Pans touching each other or oven walls.</li> <li>• Incorrect rack position.</li> <li>• Incorrect use of aluminum foil.</li> <li>• Placed 2 cookie sheets on one rack.</li> <li>• Used glass, dark, stained warped or dull finish metal pans. (Use a shiny cookie sheet.)</li> </ul> <p>Follow cookware manufacturer's instructions for oven temperature. Glassware and dark cookware such as Ecco's Baker's Secret may require lowering the oven temperature by 25°F.</p>
<b><i>Cakes don't brown on top.</i></b>	<ul style="list-style-type: none"> <li>• Incorrect rack position.</li> <li>• Temperature set too low.</li> <li>• Overmixing.</li> <li>• Too much liquid.</li> <li>• Pan size too large or too little batter in pan.</li> <li>• Oven door opened too often.</li> </ul>
<b><i>Excessive shrinkage.</i></b>	<ul style="list-style-type: none"> <li>• Too little leavening.</li> <li>• Overmixing.</li> <li>• Pan too large.</li> <li>• Temperature set too high.</li> <li>• Baking time too long.</li> <li>• Pans too close to each other or oven walls.</li> </ul>
<b><i>Uneven texture.</i></b>	<ul style="list-style-type: none"> <li>• Too much liquid.</li> <li>• Undermixing.</li> <li>• Temperature set too low.</li> <li>• Baking time too short.</li> </ul>
<b><i>Cakes have tunnels.</i></b>	<ul style="list-style-type: none"> <li>• Not enough shortening.</li> <li>• Too much baking powder.</li> <li>• Overmixing or at too high a speed.</li> <li>• Temperature set too high.</li> </ul>
<b><i>Cake not done in middle.</i></b>	<ul style="list-style-type: none"> <li>• Temperature set too high.</li> <li>• Pan too small.</li> <li>• Baking time too short.</li> </ul> <p>If additional ingredients were added to mix or recipe, expect cooking time to increase.</p>
<b><i>Pie crust edges too brown.</i></b>	<ul style="list-style-type: none"> <li>• Temperature set too high.</li> <li>• Pans touching each other or oven walls.</li> <li>• Edges of crust too thin; shield with foil.</li> </ul>
<b><i>Pies don't brown on bottom.</i></b>	<ul style="list-style-type: none"> <li>• Used shiny metal pans.</li> <li>• Temperature set too low.</li> <li>• Incorrect rack position.</li> <li>• Some frozen pies should be placed on a cookie sheet, check package directions.</li> </ul>
<b><i>Pies have soaked crust.</i></b>	<ul style="list-style-type: none"> <li>• Temperature too low at start of baking.</li> <li>• Filling too juicy.</li> <li>• Used shiny metal pans.</li> </ul>

**CAUTION**

- Be sure all packing material is removed from oven before turning on.
- Do not use oven for storing food or cookware.
- Many aerosol-type spray cans are **EXPLOSIVE** when exposed to heat and may be highly flammable. Avoid their use or storage near the oven.
- Allow steam and hot air to escape before reaching into oven to check, add, or remove food.
- Prepared Food Warning: Follow food manufacturer's instructions. If a plastic frozen food container and/or its cover distorts, warps, or is otherwise damaged during cooking, immediately discard the food and its container. The food could be contaminated.
- Follow the manufacturer's directions when using oven cooking bags.

**OVEN DOOR****CAUTION**

- **WARNING: NEVER** place excessive weight on or stand on an open oven door. This could cause the range to tip over, break the door, or injure the user.
- **NEVER** place fingers between hinge and front oven frame. Hinge arms are spring mounted. If accidentally hit, the hinge will slam shut against oven frame and could injure your fingers.

When baking, be sure oven door is completely closed. Baking results will be affected if door is not closed.

The oven door is not designed to be removed by the consumer.

When opening the oven door, allow steam and hot air to escape before reaching in oven to check, add or remove food.

**OVEN VENT****CAUTION**

- When oven is in use, the area near the oven vent opening may feel warm or hot to the touch.

The oven vent is located at the **LEFT REAR** element.

- Be sure drip bowl for the left rear element has a hole in the center to allow proper oven venting.
- Do not cover this drip bowl with aluminum foil as this will block proper oven venting and may affect baking results.

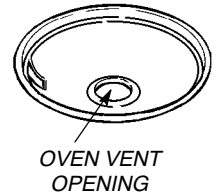
**LEVELING LEGS****CAUTION**

**WARNING:** The anti-tip bracket provided with this range must secure one of the rear leveling legs to the floor. This bracket prevents the range from accidentally tipping.

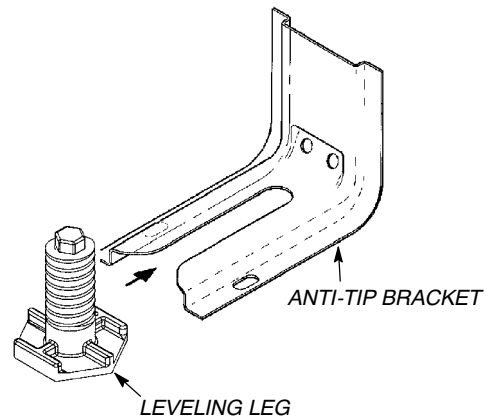

The installer should level the range when it is installed.

If the range is not level, turn the leveling legs, located at each corner of the range, until range is level. Place level on an oven rack to determine if range is level.

Cooking results can be affected if the range was not properly leveled during installation.

## OVEN RACK



### CAUTION

Do not attempt to change the rack position when the oven is hot.

The oven rack is designed with a safety lock-stop position. This prevents the rack from accidentally coming completely out of the oven when pulling the rack out to add or remove food.

#### To remove oven rack:

1. When rack is cool, pull rack straight out until it stops at the lock-stop position.

**NOTE:** If it is necessary to change rack position when rack is hot, use potholders to protect hands.

2. Tilt the front end of the rack up.
3. Continue pulling rack out of oven.

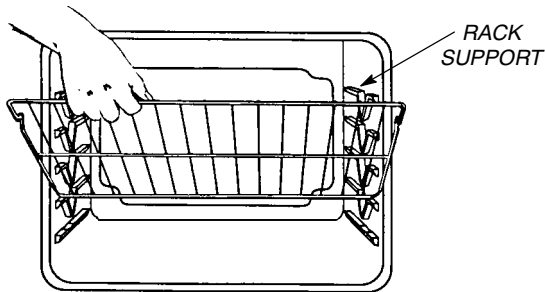

#### To replace oven rack:

1. Place rack on the rack supports in oven.
2. Tilt the front end of the rack up slightly.
3. Slide rack back until it clears the lock-stop position.
4. Lower front of rack and slide rack straight back into oven.
5. Pull rack out to the lock-stop position to be sure rack is correctly replaced. Push rack back into oven and close oven door.

## RACK POSITIONS

- For optimum results, air must circulate freely within the oven and around the food. To help ensure this, place food in the center of the oven. Allow two inches between the edge of the pan(s) and the oven walls.
- Use one rack for optimum baking results of cakes, cookies or biscuits.

Position the rack so the food is in the center of the oven. Use either rack position 2 or 3.

- If cooking on two racks, select models, stagger the food to ensure proper air flow.

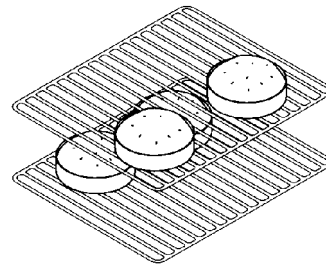

**RACK 4:** Used for most broiling and two-rack baking.

**RACK 3:** Used for most baked goods on a cookie sheet or jelly roll pan, or frozen convenience foods, or for two-rack baking.

**RACK 2:** Used for roasting small cuts of meat, large casseroles, baking loaves of bread, cakes (in either tube, bundt, or layer pans) or two-rack baking.

**RACK 1:** Used for roasting large cuts of meat and large poultry, pies, souffles, or angel food cake, or for two-rack baking.

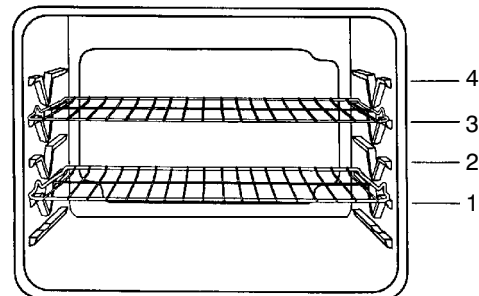

## ABOUT CLEANING PRODUCTS

Read and carefully follow the manufacturer's instructions.

Test a small inconspicuous area using a very light pressure to see if the surface may scratch or discolor. This is particularly important for porcelain enamel, highly polished or shiny metal or plastic surfaces, and painted surfaces.

**Glass Cleaners** – Bon Ami, Cinch, Glass Plus, Windex.

**Dishwashing Liquid Detergents** – Dawn, Dove, Ivory, Joy.

**Mild Liquid Spray Cleaners** – Fantastik, Formula 409.

**Non-Abrasive Cleaners** – Bon Ami, paste of baking soda and water.

**Mildly Abrasive Powder or Liquid All Purpose Cleaners** – Ajax, Barkeepers Friend, Cameo, Comet, Soft Scrub.

**Non-Abrasive or Scratchless Plastic or Nylon Scouring Pads or Sponges** – Chore Boy Plastic Cleaning Puff, Scrunge Scrub Sponges, or Scotch-Brite No Scratch, Cookware or Kitchen Sponge.

**Abrasive Scouring Pads** – S.O.S., Brillo Steel Wool Soap, Scotch-Brite Pads.

*(Brand names for the above cleaning products are registered trademarks of the respective manufacturers.)*



### CAUTION

- Be sure appliance is off and all parts are cool before handling or cleaning. This is to avoid damage and possible burns.
- If a part is removed, be sure it is correctly replaced.
- **To prevent staining or discoloration, clean appliance after each use.**

## CLEANING CHART

PARTS	CLEANING AGENTS	CLEANING PROCEDURES
<b>Broiler pan and insert, select models</b>	<ul style="list-style-type: none"> <li>• Soap and water</li> <li>• Plastic or soap filled scouring pad</li> <li>• Dishwasher</li> </ul>	<p><b>Never cover insert with aluminum foil as this prevents the fat from draining to pan below.</b></p> <ol style="list-style-type: none"> <li>1. Remove from oven after use. Cool then pour off grease.</li> <li>2. Place soapy cloth over insert and pan; let soak to loosen soil.</li> <li>3. Wash in warm soapy water. Use soap filled scouring pad to remove stubborn soil.</li> <li>4. Broiler pan and insert can be cleaned in the dishwasher.</li> </ol>
<b>Control knobs</b>	<ul style="list-style-type: none"> <li>• Soap and water</li> <li>• Mild liquid sprays</li> <li>• Glass cleaners</li> </ul>	<p>For ease of cleaning, turn off knob and remove by pulling forward.</p> <ol style="list-style-type: none"> <li>1. Wash, rinse, and dry. Do not use abrasive cleaning agents as they may scratch the finish and remove the markings.</li> <li>2. Turn on each element to be sure knobs have been correctly replaced.</li> </ol>
<b>Drip bowls, chrome</b>	<ul style="list-style-type: none"> <li>• Soap and water</li> <li>• Plastic scouring pads</li> <li>• Mild abrasive cleaners</li> <li>• Flitz Metal Polish</li> </ul>	<p><b>Do not cover drip bowls with aluminum foil.</b></p> <p>Bowls can permanently discolor over time, if exposed to excessive heat, or if soil is allowed to bake on. The discoloration will not affect the cooking performance.</p> <ol style="list-style-type: none"> <li>1. After each use, wash, rinse and dry.</li> <li>2. If heavily soiled, gently scrub with plastic scouring pad. If soil is allowed to burn on, it may be impossible to remove.</li> <li>3. A non-abrasive metal polish such as Flitz may be used to help remove blue/gold heat stains. Flitz is available in many automotive supply and hardware stores. These stains are caused by overheating, and normally occur over a period of time. They are usually permanent. Follow package directions.</li> </ol>
<b>Elements, oven and coil</b>		<ol style="list-style-type: none"> <li>1. Elements are self-cleaning. Soil will burn off as elements are used.</li> <li>2. Do not spray oven cleaner on elements, electrical hook up or connection.</li> <li>3. Do not immerse coil-type surface elements in water.</li> </ol>

# CLEANING CHART

13

PARTS	CLEANING AGENTS	CLEANING PROCEDURES
<b>Enamel, painted</b> <ul style="list-style-type: none"> <li>• Backguard</li> <li>• Oven door</li> <li>• Side panels</li> <li>• Lower panel</li> <li>• Manifold panel</li> </ul>	<ul style="list-style-type: none"> <li>• Soap and water</li> <li>• Mild liquid cleaner</li> <li>• Glass cleaner</li> </ul>	<p><b>NOTE:</b> Use dry towel or cloth to wipe up spills, especially acid (milk, lemon juice, fruit, mustard, tomato sauce) or sugary spills. Surface may discolor or dull if soil is not immediately removed. This is especially important for white surfaces.</p> <ol style="list-style-type: none"> <li>1. When cool, wash with warm soapy water, rinse and dry. Never wipe a warm or hot surface with a damp cloth as this may damage the surface and may cause a steam burn.</li> <li>2. For stubborn soil, use mildly abrasive cleaning agents such as baking soda paste or Bon Ami.</li> <li>3. Do not use abrasive, caustic or harsh cleaning agents such as steel wool pads or oven cleaners. These products will scratch or permanently damage the surface.</li> </ol>
<b>Metal finishes such as brushed aluminum, or chrome</b> <ul style="list-style-type: none"> <li>• Door handle</li> </ul>	<ul style="list-style-type: none"> <li>• Soap and water</li> <li>• Glass cleaner</li> <li>• Plastic or non-abrasive pad or sponge</li> </ul>	<ol style="list-style-type: none"> <li>1. Wash with soap and water or a glass cleaner and a soft cloth.</li> <li>2. To prevent scratching or dulling of the finish, do not use mildly abrasive, abrasive, or harsh cleaners, or caustic cleaners such as oven cleaners.</li> <li>3. To clean <b>brushed aluminum</b>: Use only soap and water or a soft cloth and glass cleaner to prevent scratching or dulling of the finish.</li> <li>4. To clean <b>brushed chrome</b> cooktop or door: <ul style="list-style-type: none"> <li>• Use a paste of baking soda and water and a soft cloth.</li> <li>• Rub with the grain to prevent scratching, dulling or streaking of the finish.</li> <li>• Use a soft cloth and mineral oil to restore luster or to remove fingerprints or smudges.</li> <li>• Clean with an automotive chrome cleaner or polisher.</li> </ul> </li> </ol>
<b>Oven rack</b>	<ul style="list-style-type: none"> <li>• Soap and water</li> <li>• Plastic scouring pad</li> <li>• Cleansing powders</li> <li>• Soap-filled scouring pad</li> </ul>	<ol style="list-style-type: none"> <li>1. Clean with soapy water.</li> <li>2. Remove stubborn soil with cleansing powder or soap-filled scouring pad. Rinse and dry.</li> </ol>
<b>Plastic finishes</b> <ul style="list-style-type: none"> <li>• Knobs</li> </ul>	<ul style="list-style-type: none"> <li>• Soap and water</li> <li>• Non-abrasive plastic pad or sponge</li> <li>• Glass cleaner</li> </ul>	<p><b>NOTE:</b> To prevent staining or discoloration, wipe up fat, grease or acid (tomato, lemon, vinegar, milk, fruit juice, marinade) immediately with a dry paper towel or cloth.</p> <ol style="list-style-type: none"> <li>1. When cool, clean with soap and water, rinse, and dry.</li> <li>2. Use a glass cleaner and a soft cloth.</li> </ol> <p><b>NOTE:</b> Never use oven cleaners, abrasive or caustic liquid or powdered cleansers on plastic finishes. These cleaning agents will scratch or mar finish.</p>
<b>Porcelain enamel</b> <ul style="list-style-type: none"> <li>• Cooktop</li> <li>• Oven interior</li> </ul>	<ul style="list-style-type: none"> <li>• Soap and water</li> <li>• Paste of baking soda and water</li> <li>• Non-abrasive plastic pad or sponge</li> <li>• Oven cleaner</li> </ul>	<p>Porcelain enamel is glass fused on metal and may crack or chip with misuse. It is acid resistant, not acid proof. All spillovers, especially acid or sugar spillovers, should be wiped up immediately with a dry cloth. This is especially important around the vent opening for smoothtop cooktop. Surface may discolor or dull if soil is not removed.</p> <ol style="list-style-type: none"> <li>1. When cool, wash with soapy water, rinse and dry.</li> <li>2. Never wipe off a warm or hot surface with a damp cloth. This may cause cracking and chipping.</li> <li>3. Never use oven cleaners, abrasive or caustic cleaning agents on exterior finish of range. Oven cleaners can only be used on porcelain oven cavity.</li> </ol>
<b>Silicone Rubber Door Gasket</b>	<ul style="list-style-type: none"> <li>• Soap and water</li> </ul>	<p>Door gasket is located on the oven front frame. <b>DO NOT REMOVE GASKET.</b> Wash with soap. Rinse thoroughly.</p>

**CAUTION**

- Do not attempt to service this appliance yourself unless directed to do so in this manual or the chart below. Refer all other servicing to a qualified servicer or call us at **1-800-688-9900**.
- Locate and mark circuit breaker or fuse. Never replace a blown fuse or reset a circuit breaker until you know what caused the problem. Always replace a blown fuse with one of the correct amperage, do not use a substitute.
- Always disconnect power to unit **before** any servicing by tripping circuit breaker to the OFF position or by removing the fuse.

**TROUBLESHOOTING CHART**

PROBLEM	POSSIBLE CAUSES	SUGGESTED CORRECTIONS
<b>Part or all of appliance does not operate.</b>	<ol style="list-style-type: none"> <li>1. Range is disconnected from power or is loosely connected to power.</li> <li>2. Tripped circuit breaker or blown fuse.</li> <li>3. Power supply has been interrupted.</li> <li>4. Surface or oven controls not set properly.</li> </ol>	<ol style="list-style-type: none"> <li>1. Check to be sure plug is securely inserted into wall receptacle.</li> <li>2. Check or re-set circuit breaker. Check or replace fuse.</li> <li>3. Wait until power has been restored.</li> <li>4. See pages 5, 6 and 7.</li> </ol>
<b>Surface or oven elements fail to operate or heat food.</b>	<ol style="list-style-type: none"> <li>1. Range is disconnected from power or is loosely connected to power.</li> <li>2. Tripped circuit breaker or blown fuse.</li> <li>3. Power supply has been interrupted.</li> <li>4. Surface or oven controls not set properly.</li> <li>5. Surface element is not properly installed.</li> <li>6. Oven was not set to correct temperature.</li> <li>7. Oven was not preheated properly.</li> <li>8. Defective part.</li> </ol>	<ol style="list-style-type: none"> <li>1. Check to be sure plug is securely inserted into wall receptacle.</li> <li>2. Check or re-set circuit breaker. Check or replace fuse.</li> <li>3. Wait until power has been restored.</li> <li>4. See pages 5, 6 and 7.</li> <li>5. See page 6 for instructions on how to replace surface element.</li> <li>6. Set oven to temperature recommended in recipe.</li> <li>7. Allow oven to preheat 8 to 15 minutes. Then place food in oven.</li> <li>8. Have authorized servicer replace part.</li> </ol>
<b>Baking results are not what you expected.</b> <ul style="list-style-type: none"> <li>• <b>Uneven browning (too dark on top or bottom).</b></li> <li>• <b>Underdone or overdone.</b></li> <li>• <b>Browning is too dark or light.</b></li> <li>• <b>Cake is not level.</b></li> </ul>	<ol style="list-style-type: none"> <li>1. Oven is too hot or too cool.</li> <li>2. Food not positioned correctly in oven.</li> <li>3. Used incorrect pan.</li> <li>4. Used aluminum foil incorrectly.</li> <li>5. Oven rack was crowded with pans.</li> <li>6. Used unreliable recipe or did not follow recipe.</li> <li>7. Oven vent was blocked.</li> <li>8. Range is not level.</li> </ol>	<ol style="list-style-type: none"> <li>1. Select correct oven temperature. When baking, always preheat oven before adding food.</li> <li>2. See rack placement on page 11.</li> <li>3. Dark pans produce dark browning. Select shiny aluminum pans or reduce the oven temperature by 25°F. See page 8.</li> <li>4. Never use foil to cover an oven rack. Place a small piece of foil on the rack below the rack holding the pan. See page 7.</li> <li>5. Stagger pans on rack. Allow 1 to 2-inches between pans and oven walls.</li> <li>6. Select recipes from reliable sources. Read and carefully follow instructions and do not substitute ingredients.</li> <li>7. See page 10 for information on oven vent.</li> <li>8. See page 10 for instructions on leveling range.</li> </ol>

PROBLEM	POSSIBLE CAUSES	SUGGESTED CORRECTIONS
<b>Baking results differ from previous oven.</b>	<ol style="list-style-type: none"> <li>Oven seems hotter or cooler than your previous oven.</li> </ol>	<ol style="list-style-type: none"> <li>Oven temperatures may vary between the new and the old oven. As ovens age, the oven temperature often “drifts” and may become hotter or cooler. Also, newer ovens may operate differently from older ovens. You should expect some differences in baking results.</li> </ol>
<b>Food not broiling properly.</b>	<ol style="list-style-type: none"> <li>Oven incorrectly set.</li> <li>Used incorrect rack position.</li> <li>Broil element was not preheated.</li> <li>Used aluminum foil incorrectly.</li> <li>Oven door was closed during broiling.</li> </ol>	<ol style="list-style-type: none"> <li>See page 7.</li> <li>See page 11 for information on broiling.</li> <li>For optimum browning, preheat the broil element for 3 minutes before placing food in the oven.</li> <li>The broiler pan can be lined with foil; <b>never</b> line the broiler insert with foil.</li> <li>Always leave door opened to the broil stop position (opened about 4-inches) during broiling.</li> </ol>
<b>Oven smokes excessively during broiling.</b>	<ol style="list-style-type: none"> <li>Food placed too close to broil element.</li> <li>Broiler insert covered with aluminum foil.</li> <li>Meat is too fatty.</li> <li>Marinade not completely drained before broiling.</li> <li>Basted meat too early during broiling.</li> <li>Used a soiled broiler pan.</li> </ol>	<ol style="list-style-type: none"> <li>Move broiler pan down one rack position.</li> <li>Never cover insert with foil as this prevents fat from draining to pan below.</li> <li>Trim excess fat before broiling.</li> <li>Completely drain marinade from meat.</li> <li>Baste meat during the last few minutes of cooking.</li> <li>Always clean broiler pan and insert after use.</li> </ol>
<b>Strong odor or light smoke when oven is turned on the first few times.</b>	<p>This is normal for a new range and will disappear after a few uses. Opening a window or turning on a fan will help remove the smoke and odor.</p>	

---

# MAYTAG® MAJOR APPLIANCE WARRANTY

---

## LIMITED WARRANTY

For one year from the date of purchase, when this major appliance is operated and maintained according to instructions attached to or furnished with the product, Maytag brand of Whirlpool Corporation or Whirlpool Canada LP (hereafter "Maytag") will pay for factory specified parts and repair labor to correct defects in materials or workmanship. Service must be provided by a Maytag designated service company. This limited warranty is valid only in the United States or Canada and applies only when the major appliance is used in the country in which it was purchased. Outside the 50 United States and Canada, this limited warranty does not apply. Proof of original purchase date is required to obtain service under this limited warranty.

---

## ITEMS EXCLUDED FROM WARRANTY

### This limited warranty does not cover:

1. Service calls to correct the installation of your major appliance, to instruct you on how to use your major appliance, to replace or repair house fuses, or to correct house wiring or plumbing.
2. Service calls to repair or replace appliance light bulbs, air filters or water filters. Consumable parts are excluded from warranty coverage.
3. Repairs when your major appliance is used for other than normal, single-family household use or when it is used in a manner that is contrary to published user or operator instructions and/or installation instructions.
4. Damage resulting from accident, alteration, misuse, abuse, fire, flood, acts of God, improper installation, installation not in accordance with electrical or plumbing codes, or use of consumables or cleaning products not approved by Maytag.
5. Cosmetic damage, including scratches, dents, chips or other damage to the finish of your major appliance, unless such damage results from defects in materials or workmanship and is reported to Maytag within 30 days from the date of purchase.
6. Any food loss due to refrigerator or freezer product failures.
7. Costs associated with the removal from your home of your major appliance for repairs. This major appliance is designed to be repaired in the home and only in-home service is covered by this warranty.
8. Repairs to parts or systems resulting from unauthorized modifications made to the appliance.
9. Expenses for travel and transportation for product service if your major appliance is located in a remote area where service by an authorized Maytag servicer is not available.
10. The removal and reinstallation of your major appliance if it is installed in an inaccessible location or is not installed in accordance with published installation instructions.
11. Major appliances with original model/serial numbers that have been removed, altered or cannot be easily determined. This warranty is void if the factory applied serial number has been altered or removed from your major appliance.

The cost of repair or replacement under these excluded circumstances shall be borne by the customer.

---

## DISCLAIMER OF IMPLIED WARRANTIES; LIMITATION OF REMEDIES

CUSTOMER'S SOLE AND EXCLUSIVE REMEDY UNDER THIS LIMITED WARRANTY SHALL BE PRODUCT REPAIR AS PROVIDED HEREIN. IMPLIED WARRANTIES, INCLUDING WARRANTIES OF MERCHANTABILITY OR FITNESS FOR A PARTICULAR PURPOSE, ARE LIMITED TO ONE YEAR OR THE SHORTEST PERIOD ALLOWED BY LAW. MAYTAG SHALL NOT BE LIABLE FOR INCIDENTAL OR CONSEQUENTIAL DAMAGES. SOME STATES AND PROVINCES DO NOT ALLOW THE EXCLUSION OR LIMITATION OF INCIDENTAL OR CONSEQUENTIAL DAMAGES, OR LIMITATIONS ON THE DURATION OF IMPLIED WARRANTIES OF MERCHANTABILITY OR FITNESS, SO THESE EXCLUSIONS OR LIMITATIONS MAY NOT APPLY TO YOU. THIS WARRANTY GIVES YOU SPECIFIC LEGAL RIGHTS, AND YOU MAY ALSO HAVE OTHER RIGHTS WHICH VARY FROM STATE TO STATE OR PROVINCE TO PROVINCE.

---

If outside the 50 United States and Canada, contact your authorized Maytag dealer to determine if another warranty applies.

If you need service, first see the "Troubleshooting" section of the Use & Care Guide. After checking "Troubleshooting," you may find additional help by checking the "Assistance or Service" section or by calling Maytag. In the U.S.A., call **1-800-688-9900**. In Canada, call **1-800-807-6777**.

9/07